

ACTIVE METAL™

BEYOND DURABLE.™

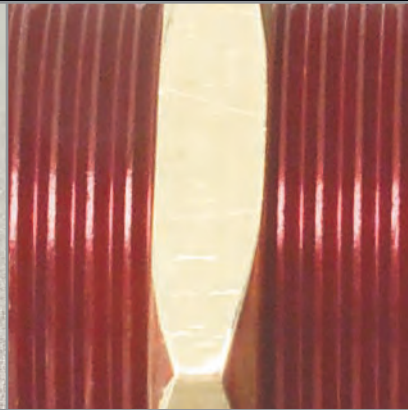
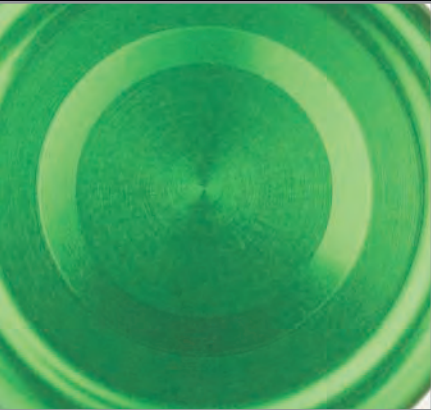

ITW ActiveTouch™
SENSORS, SWITCHES, ELECTRONIC CONTROLS

ABOUT ACTIVE TOUCH™ TECHNOLOGY

ActiveTouch patented touch-sensitive technology brings a whole new level of durability to switches, sensors and control systems. Whether you define durability as long life, resistance to temperature and environment, resistance to physical damage or just a robust design, our technology excels at each of these criteria. Imagine switches with no moving parts and virtually unlimited lifespan. Imagine seamless control panels where water or chemical intrusion is impossible. Imagine switches made from thick stainless steel—impervious to even a hammer blow. Imagine sensors integrated with intelligence to report diagnostic information or adapt to the surrounding environment to ensure uninterrupted operation. All of these are possible and more. Existing touch-sensitive technologies are fragile, limiting the scope of their uses and applications. With ActiveMetal products, you can have the advantage of touch-sensitive technology without sacrificing durability.

We are confident that you will find this the most durable technology available today.
ActiveTouch—Beyond Durable.

CAN IT DO “THIS”?

CAN IT DO “THAT”?

In the past, each time you wrestled with such issues—trying to decide whether to use “this” technology or “that” one—you had to research a dizzying series of strength and weakness characteristics.

Welcome to ActiveMetal, where you’ll find that the answers to most of your design and application questions get a very quick, positive “yes” answer. Now, after seven years of intense research and development, ActiveMetal is here, offering a switch and sensor technology that masters a vast and diverse array of those same parameters in a most unique way.

ALL ACTIVEMETAL APPLICATIONS—

- Are impervious to moisture—including direct exposure to pressurized water and can even work underwater (NEMA 4X/IP68).
- Can be operated with gloved or protected hands.
- Are vandal-proof and explosion-proof.
- Can withstand shock and vibration—even major impact from a hammer.
- Offer variable output or pressure-sensitive operation.
- Can operate in extended temperatures.
- Are not affected by sand or dust.
- Can be used with overlays and LED options.
- Are unaffected by, and not a source of, electromagnetic radiation and can tolerate 25kV ESD.



What Other Technology Provides Unlimited Opportunities Like This?

ActiveMetal™

800.544.3354

www.itwactivetouch.com

ActiveMetal™

About ActiveTouch™ Technology	IFC
Can It Do “This”? Can It Do “That”?	IFC
How ActiveMetal Works	2 – 3
A Technology Comparison	4
19mm Switches	5 – 12
19mm Specifications	7
Stainless Steel	8 – 9
5 VDC Input / Digital Output	8
5 VDC Input / Open Collector Output	9
10 – 24 VDC Input / Open Collector Output	9
Aluminum	10 – 12
5 VDC Input / Digital Output	10
5 VDC Input / Open Collector Output	11
10 – 24 VDC Input / Open Collector Output	12
22mm Switches	13 – 22
22mm Specifications	7
Stainless Steel	16 – 17
5 VDC Input / Digital Output	16
5 VDC Input / Open Collector Output	17
10 – 24 VDC Input / Open Collector Output	17
Aluminum	18 – 20
5 VDC Input / Digital Output	18
5 VDC Input / Open Collector Output	19
10 – 24 VDC Input / Open Collector Output	20
Plastic	21 – 22
5 VDC Input / Digital Output	21
5 VDC Input / Open Collector Output	22
10 – 24 VDC Input / Open Collector Output	22
30mm Switches	23 – 30
30mm Specifications	25
Stainless Steel	26 – 27
5 VDC Input / Digital Output	26
5 VDC Input / Open Collector Output	27
10 – 24 VDC Input / Open Collector Output	27
Aluminum	28 – 30
5 VDC Input / Digital Output	28
5 VDC Input / Open Collector Output	29
10 – 24 VDC Input / Open Collector Output	30
38mm Switches	31 – 34
38mm Specifications	33
Stainless Steel	34
5 VDC Input / Digital Output	34
Appendix	35 – 37
Technical information	37

800.544.3354

www.itwactivetouch.com

HOW ACTIVE METAL WORKS

Step 2

The basic principle is that a material capable of supporting shear and torsional mechanical waves at ultrasonic frequencies can have those waves trapped or localized by contouring its surface. These trapped energy regions are set into motion with transducers and act as high quality resonators.



ActiveMetal Products

Step 1

When the time to a threshold value is lower than the preset value, the microcontroller is programmed to indicate switch actuation. This is a continuous process occurring every few milliseconds.

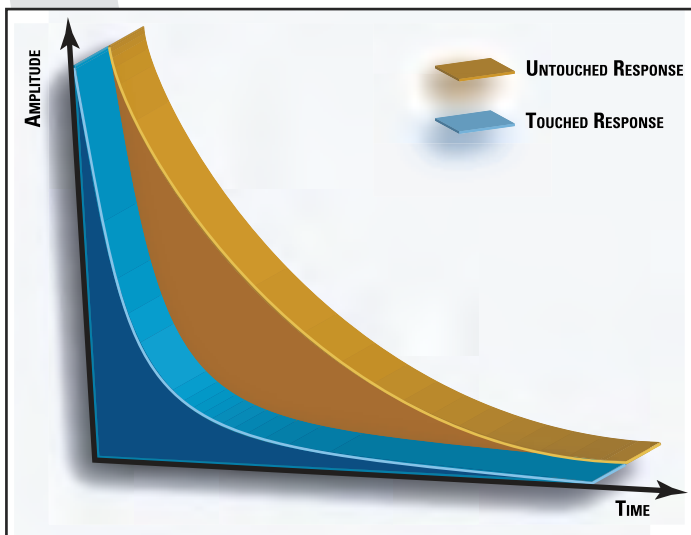

The decay rate has changed. Actuation is triggered

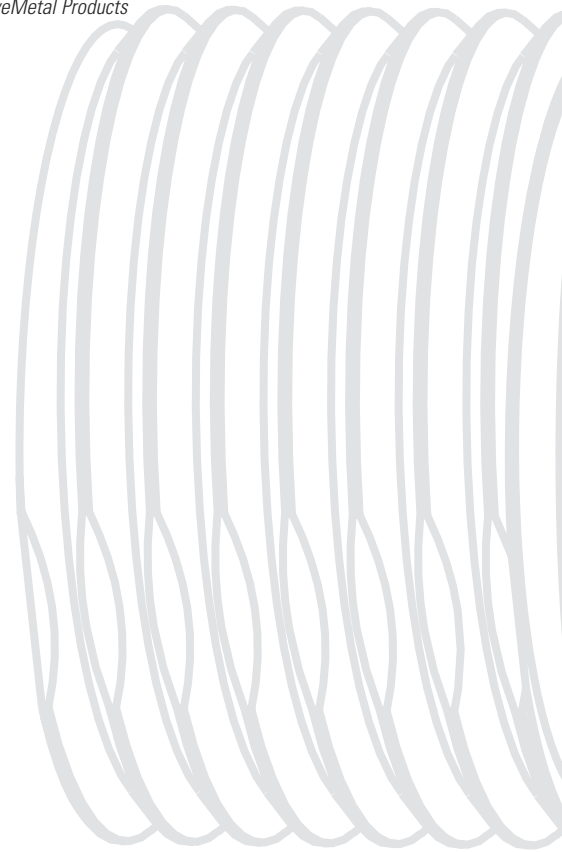

Step 5

When the surface of a switch plate is contoured as depicted here, it creates raised regions or Resonant Cavities that trap ultrasonic energy in a defined area or column within the material.

The switch operates with ultrasonic energy, and the metal plate acts as a very effective shield. Despite the use of acoustic resonance, vibration in these sensors and mechanical vibrations from external sources do not influence sensor performance.

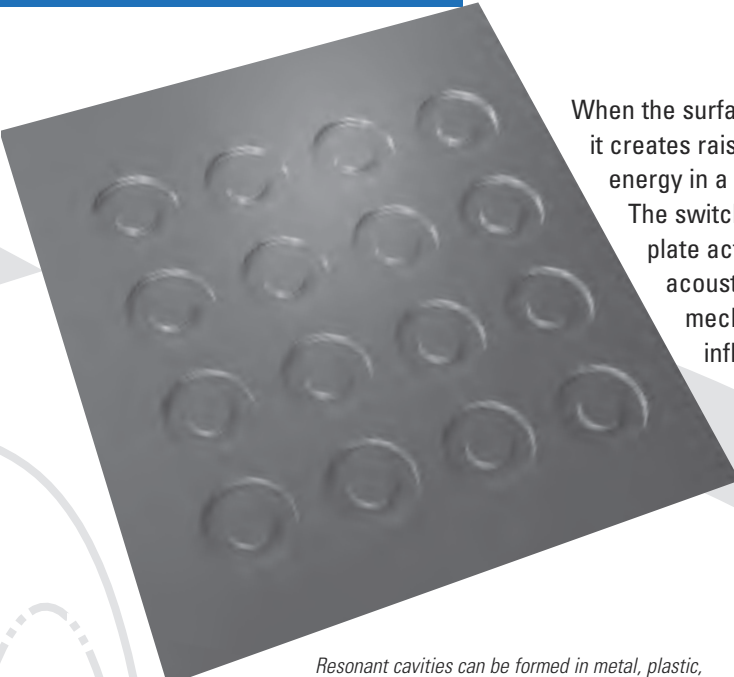

Resonant cavities can be formed in metal, plastic, ceramics, or homogeneous granite

Step 3

When a resonator is set into vibration in the MHz range by a properly positioned ultrasonic transducer, a wave motion is induced. The motion is confined to the shape of a cylinder, and it extends through the thickness of the metal.

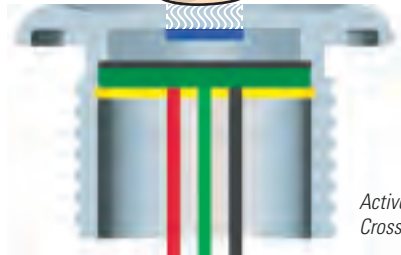

ActiveMetal Switch Cross-section

Motion is initiated by an electrical impulse to the transducer, then as the vibration decays or "rings down", like a bell that has been struck. A finger or gloved hand touching the front surface of the resonant cavity dampens the vibration and reduces the region's ring-down time. This reduction in ring-down time (decay rate) is detected with an inexpensive microcontroller which is easily multiplexed for multiple switch positions.

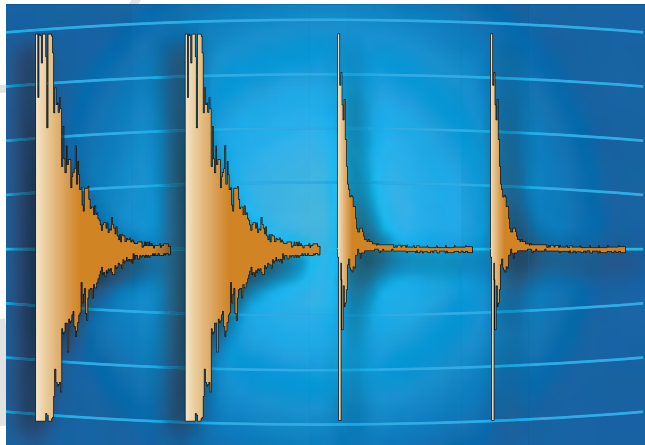

Resonant ring-down reduction waveform — Dampened ring-down reduction waveform

Step 4

BEYOND DURABLE.™

TECHNOLOGY / CHARACTERISTICS	ACTIVE METAL	CAPACITIVE	ELECTRO-MECHANICAL	EMF	PIEZO
LIFE / DURABILITY	100+ million cycles Virtually unlimited life, No moving parts, impact, shock and vibration resistant	20+ million cycles Long Life, Durability limited by materials and thickness	Up to 10 million cycles, Low / Med. Life, Affected by impact, shock, vibration and current (load)	20+ million cycles Long Life, Durability limited by materials and thickness	20+ million cycles Long Life, Durability limited by materials and thickness, Affected by impact, shock, vibration and current (load)
PANEL THICKNESS	0.0625" (1.58 mm) to 0.5" (12.7 mm)	Less Than 0.125" (3.175 mm)	0.5" (12.7 mm) with bushing or panel mount options	Less Than 0.25" (6.35 mm)	0.030" (0.762 mm)
MATERIALS	Aluminum, stainless-steel, and plastics	Metal (only when isolated), plastics and glass	Any	No metals, only non-conductive plastics and glass	Metal only
INTERFACE	Finger, glove, rubber, overlays	Conductive materials only	Any	Conductive materials only	Any
SUSCEPTIBILITY INTERFERENCE	None	EMI, ESD susceptible	None	RFI, EMI and ESD susceptible	ESD susceptible
INTELLIGENCE	Self-adapting, Self-diagnosing, Error reporting, Available upon request (special order)	None, cannot distinguish between accidental and intentional actuations	None	None, cannot distinguish between accidental and intentional actuations	None
SEALING	Completely sealed, Not affected by water pressure	Partially sealed, Moisture causes false actuations	Available	Partially sealed, Moisture can interfere with sensor operation	Sealed, but can not be submerged and will not function under pressure
DESIGN LIMITATIONS	Limited only by your imagination	Cannot be integrated into existing enclosures Cannot be sterilized or exposed to moisture, explosive, and corrosive conditions	Require panel cut-outs and can not be located on curved surfaces	limited use in harsh environments	Suited for use only on extremely thin metal surfaces and never with elastomeric overlays Most expensive in high volumes

800.544.3354

www.itwactivetouch.com



19mm SWITCHES

BEYOND DURABLE.™

||TW ActiveTouch™
SENSORS, SWITCHES, ELECTRONIC CONTROLS

BEYOND DURABLE™

MECHANICAL SPECIFICATIONS

- Maximum Actuation Force:
Level 2 Sensitivity: < 5 lbs. (22.2 N)
ADA Compliant
- Materials: Stainless Steel (316),
Aluminum (6061) with Type II Anodization
- Mechanism: 100% Solid-state, No Moving Parts
- Operational Life: Tested +20MM cycles, -60°C to 85°C (Typical)
- Mounting Panel Thickness: 0.0625" (1.58mm) to
0.500" (12.7mm)
- Mounting Panel Thickness with oriented
Double "D" Flats: 0.090" (2.3mm) to
0.500" (12.7mm)
- Mounting: Brass Nut (15 Inch Pounds — Max),
AS568A-019 Butyl Rubber O-ring

ENVIRONMENTAL SPECIFICATIONS

- Operating Temperature Range: -40° C to +85° C (Typical)
- Storage Temperature Range: -60° C to +165° C (Typical)
- Relative Humidity: No Effect
- Ingress Protection: IP68 (submerged in 3 feet without a panel for 96 hours)
- Shock: Tested to 30g in each Axis
(drop test from 20 ft to concrete)
- Vibration: Tested at 4 hours each Axis
(actuated during vibration)
- Impact: 1kg Shock Test

ELECTRICAL SPECIFICATIONS

- Voltage: +5 VDC ± 5%, or
+10–24 VDC
- Current: 100mA
- Contact Resistance: None
- Contact Bounce: None
- EMI/RFI: No Effect
- ESD: 25kv in each method
- Wire Leads: 24 AWG,
12" long,
105C Insulation

FUNCTIONAL OPERATION SPECIFICATIONS

- Momentary / Alternate
- Normally Open / Normally Closed
(Open Collector Output)
- Normally High, 5V / Normally Low, 0V
(Digital Output)
- Make / Break via Transistor

PANEL CUTOUTS:

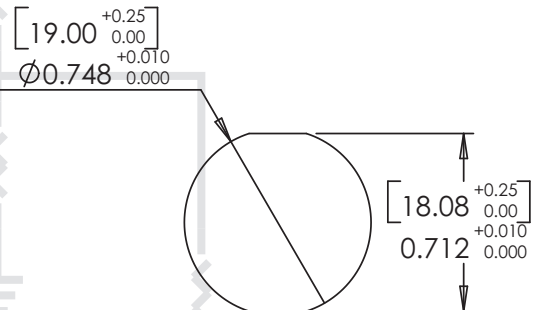

800.544.3354

www.itwactivetouch.com

U.S. Patents: 6933932, 7026943, 7053529, 7106310.
U.S. Patents Pending: 03797865.7, 04776790.0, 04776791.8, 02761841.2, 02763786.7, 04754763.4

5 VDC Input / Digital Output

BEYOND DURABLE.™

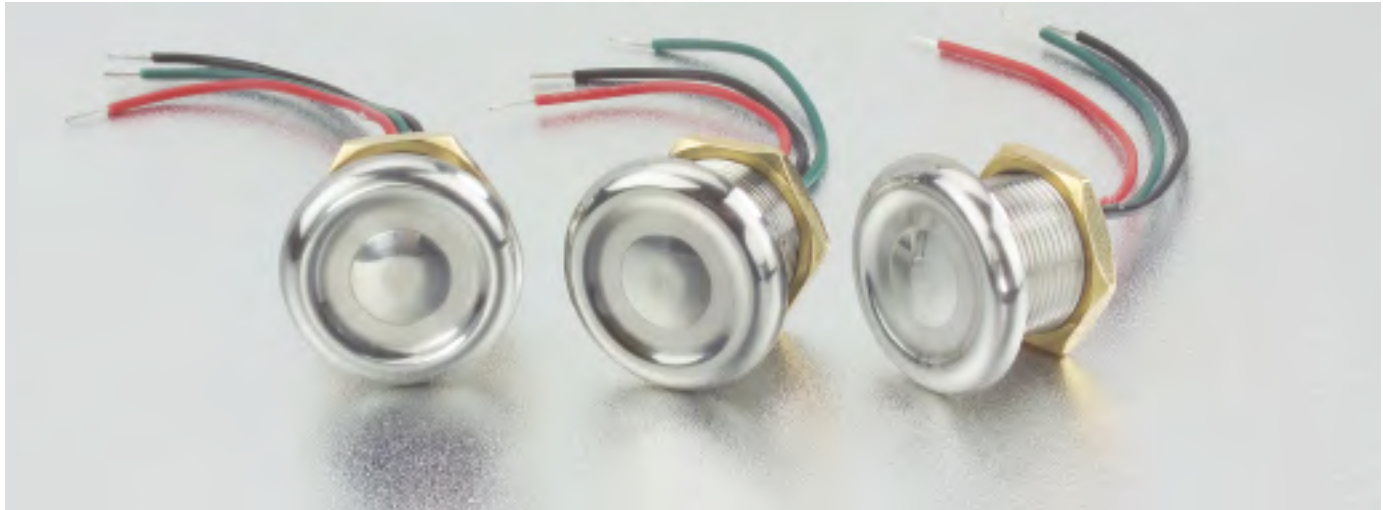

5 VDC Input / Digital Output:

19mm Stainless Steel (316) switch with 5 VDC input and digital output. Either momentary or alternate action programmed to level 2 sensitivity. Each switch has 24 AWG, 12" long, insulated wire leads.

Part Number	Normally Open	Normally Closed	Normally High, 5V	Normally Low, 0V	Momentary Action	Alternate Action	Sensitivity Level	Color
T01-011901-001-NH-M-2		✓		✓		2	ST	
T01-011901-001-NH-A-2		✓			✓	2	ST	
T01-011901-001-NL-M-2			✓	✓		2	ST	
T01-011901-001-NL-A-2			✓		✓	2	ST	

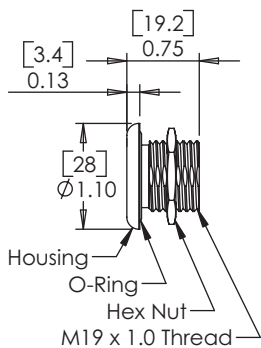

Detailed technical information on [Input /Output](#) types, [Switch Status](#), [Switch Action](#), [Sensitivity Levels](#), and [Mounting Information](#) can be found in the [Appendix starting on page 37](#).

800.544.3354

Contact an Authorized Distributor or Factory for Pricing

www.itwactivetouch.com

ActiveMetal™

BEYOND DURABLE™

5 VDC or 10 – 24 VDC Input / Open Collector Output

5 VDC Input / Open Collector Output:

19mm Stainless Steel (316) switch with 5 VDC input and open collector output. Either momentary or alternate action programmed to level 2 sensitivity. Each switch has 24 AWG, 12" long, insulated wire leads.

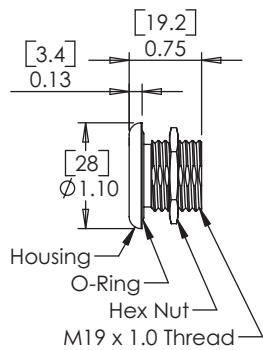

Part Number	Normally Open	Normally Closed	Normally High, 5V	Normally Low, 0V	Momentary Action	Alternate Action	Sensitivity Level	Color
T01-011902-001-NO-M-2	✓			✓		2	ST	
T01-011902-001-NO-A-2	✓				✓	2	ST	
T01-011902-001-NC-M-2		✓		✓		2	ST	
T01-011902-001-NC-A-2		✓			✓	2	ST	

Detailed technical information on [Input /Output](#) types, [Switch Status](#), [Switch Action](#), [Sensitivity Levels](#), and [Mounting Information](#) can be found in the [Appendix starting on page 37](#).

10 – 24 VDC Input / Open Collector Output:

19mm Stainless Steel (316) switch with 10–24 VDC input and open collector output. Either momentary or alternate action programmed to level 2 sensitivity. Each switch has 24 AWG, 12" long, insulated wire leads.

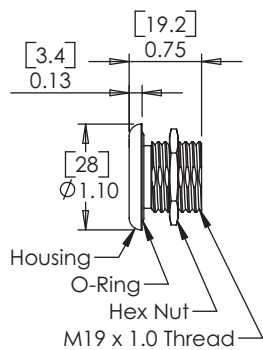

Part Number	Normally Open	Normally Closed	Normally High, 5V	Normally Low, 0V	Momentary Action	Alternate Action	Sensitivity Level	Color
T01-011903-001-NO-M-2	✓			✓		2	ST	
T01-011903-001-NO-A-2	✓				✓	2	ST	
T01-011903-001-NC-M-2		✓		✓		2	ST	
T01-011903-001-NC-A-2		✓			✓	2	ST	

Detailed technical information on [Input /Output](#) types, [Switch Status](#), [Switch Action](#), [Sensitivity Levels](#), and [Mounting Information](#) can be found in the [Appendix starting on page 37](#).

800.544.3354

www.itwactivetouch.com

Contact an Authorized Distributor or Factory for Pricing

5 VDC Input / Digital Output

BEYOND DURABLE.™



5 VDC Input / Digital Output:

19mm Aluminum Alloy (6061) switch, with Type II anodization and 5 VDC input and digital output. Either momentary or alternate action programmed to level 2 sensitivity. Each switch has 24 AWG, 12" long, insulated wire leads.

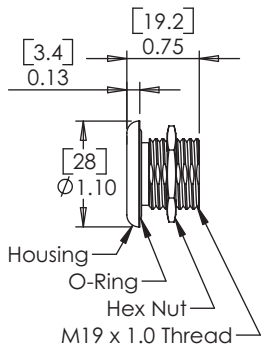

Part Number	Normally Open	Normally Closed	Normally High, 5V	Normally Low, 0V	Momentary Action	Alternate Action	Sensitivity Level	Color
T01-021901-001-NH-M-2		✓		✓		2	CLR	
T01-021901-001-NH-A-2		✓			✓	2	CLR	
T01-021901-001-NL-M-2			✓	✓		2	CLR	
T01-021901-001-NL-A-2			✓		✓	2	CLR	
T01-021901-002-NH-M-2		✓		✓		2	BLK	
T01-021901-002-NH-A-2		✓			✓	2	BLK	
T01-021901-002-NL-M-2			✓	✓		2	BLK	
T01-021901-002-NL-A-2			✓		✓	2	BLK	
T01-021901-003-NH-M-2		✓		✓		2	RED	
T01-021901-003-NH-A-2		✓			✓	2	RED	
T01-021901-003-NL-M-2			✓	✓		2	RED	
T01-021901-003-NL-A-2			✓		✓	2	RED	
T01-021901-004-NH-M-2		✓		✓		2	GRN	
T01-021901-004-NH-A-2		✓			✓	2	GRN	
T01-021901-004-NL-M-2			✓	✓		2	GRN	
T01-021901-004-NL-A-2			✓		✓	2	GRN	

Detailed technical information on [Input /Output](#) types, [Switch Status](#), [Switch Action](#), [Sensitivity Levels](#), and [Mounting Information](#) can be found in the [Appendix starting on page 37](#).

800.544.3354

Contact an Authorized Distributor or Factory for Pricing

www.itwactivetouch.com

ActiveMetal™

BEYOND DURABLE™

5 VDC Input / Open Collector Output



**5 VDC Input /
Open Collector Output:**

19mm Aluminum Alloy (6061) switch, with Type II anodization and 5 VDC input and open collector output. Either momentary or alternate action programmed to level 2 sensitivity. Each switch has 24 AWG, 12" long, insulated wire leads.

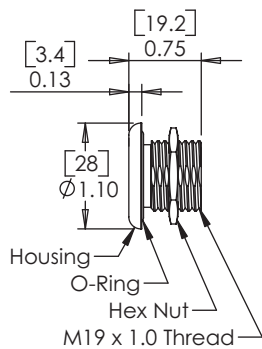

Part Number	Normally Open	Normally Closed	Normally High, 5V	Normally Low, 0V	Momentary Action	Alternate Action	Sensitivity Level	Color
T01-021902-001-NO-M-2	✓			✓		2	CLR	
T01-021902-001-NO-A-2	✓			✓		2	CLR	
T01-021902-001-NC-M-2		✓		✓		2	CLR	
T01-021902-001-NC-A-2		✓		✓		2	CLR	
T01-021902-002-NO-M-2	✓			✓		2	BLK	
T01-021902-002-NO-A-2	✓			✓		2	BLK	
T01-021902-002-NC-M-2		✓		✓		2	BLK	
T01-021902-002-NC-A-2		✓		✓		2	BLK	
T01-021902-003-NO-M-2	✓			✓		2	RED	
T01-021902-003-NO-A-2	✓			✓		2	RED	
T01-021902-003-NC-M-2		✓		✓		2	RED	
T01-021902-003-NC-A-2		✓		✓		2	RED	
T01-021902-004-NO-M-2	✓			✓		2	GRN	
T01-021902-004-NO-A-2	✓			✓		2	GRN	
T01-021902-004-NC-M-2		✓		✓		2	GRN	
T01-021902-004-NC-A-2		✓		✓		2	GRN	

Detailed technical information on [Input /Output](#) types, [Switch Status](#), [Switch Action](#), [Sensitivity Levels](#), and [Mounting Information](#) can be found in the [Appendix starting on page 37](#).

800.544.3354

www.itwactivetouch.com

Contact an Authorized Distributor or Factory for Pricing

10 – 24 VDC Input / Open Collector Output

BEYOND DURABLE.™



10 – 24 VDC Input / Open Collector Output:

19mm Aluminum Alloy (6061) switch, with Type II anodization and 10–24 VDC input and open collector output. Either momentary or alternate action programmed to level 2 sensitivity. Each switch has 24 AWG, 12" long, insulated wire leads.

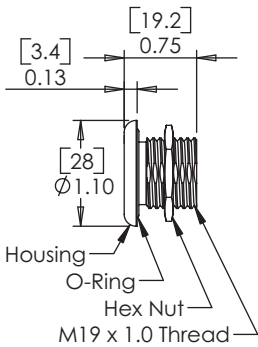

Part Number	Normally Open	Normally Closed	Normally High, 5V	Normally Low, 0V	Momentary Action	Alternate Action	Sensitivity Level	Color
T01-021903-001-NO-M-2	✓			✓		2	CLR	
T01-021903-001-NO-A-2	✓				✓	2	CLR	
T01-021903-001-NC-M-2		✓		✓		2	CLR	
T01-021903-001-NC-A-2		✓			✓	2	CLR	
T01-021903-002-NO-M-2	✓			✓		2	BLK	
T01-021903-002-NO-A-2	✓				✓	2	BLK	
T01-021903-002-NC-M-2		✓		✓		2	BLK	
T01-021903-002-NC-A-2		✓			✓	2	BLK	
T01-021903-003-NO-M-2	✓			✓		2	RED	
T01-021903-003-NO-A-2	✓				✓	2	RED	
T01-021903-003-NC-M-2		✓		✓		2	RED	
T01-021903-003-NC-A-2		✓			✓	2	RED	
T01-021903-004-NO-M-2	✓			✓		2	GRN	
T01-021903-004-NO-A-2	✓				✓	2	GRN	
T01-021903-004-NC-M-2		✓		✓		2	GRN	
T01-021903-004-NC-A-2		✓			✓	2	GRN	

Detailed technical information on [Input /Output](#) types, [Switch Status](#), [Switch Action](#), [Sensitivity Levels](#), and [Mounting Information](#) can be found in the [Appendix starting on page 37](#).

800.544.3354

Contact an Authorized Distributor or Factory for Pricing

www.itwactivetouch.com

ActiveMetal™



22mm Switches

BEYOND DURABLE.™

///TW ActiveTouch™
SENSORS, SWITCHES, ELECTRONIC CONTROLS

BEYOND DURABLE™

MECHANICAL SPECIFICATIONS

- Maximum Actuation Force:
Level 2 Sensitivity: < 5 lbs. (22.2 N)
ADA Compliant
- Materials: Stainless Steel (316),
Aluminum (6061) with Type II Anodization,
Plastic (PPS)
- Mechanism: 100% Solid-state, No Moving Parts
- Operational Life: Tested +20MM cycles, -60°C to 85°C (Typical)
- Mounting Panel Thickness: 0.050" (1.27mm) to
0.500" (12.7mm)
- Mounting Panel Thickness with oriented
Double "D" Flats: 0.090" (2.3mm) to
0.500" (12.7mm)
- Mounting: Brass Nut (15 Inch Pounds — Max),
AS568A-021 Butyl Rubber O-ring

ENVIRONMENTAL SPECIFICATIONS

- Operating Temperature Range: -40° C to +85° C (Typical)
- Storage Temperature Range: -60° C to +165° C (Typical)
- Relative Humidity: No Effect
- Ingress Protection: IP68 (submerged in 3 feet without a panel for 96 hours)
- Shock: Tested to 30g in each Axis
(drop test from 20 ft to concrete)
- Vibration: Tested at 4 hours each Axis
(actuated during vibration)
- Impact: 1kg Shock Test

ELECTRICAL SPECIFICATIONS

- Voltage: +5 VDC ± 5%, or
+10–24 VDC
- Current: 100mA
- Contact Resistance: None
- Contact Bounce: None
- EMI/RFI: No Effect
- ESD: 25kv in each method
- Wire Leads: 24 AWG,
12" long,
105C Insulation

FUNCTIONAL OPERATION SPECIFICATIONS

- Momentary / Alternate
- Normally Open / Normally Closed
(Open Collector Output)
- Normally High, 5V / Normally Low, 0V
(Digital Output)
- Make / Break via Transistor

PANEL CUTOUTS:

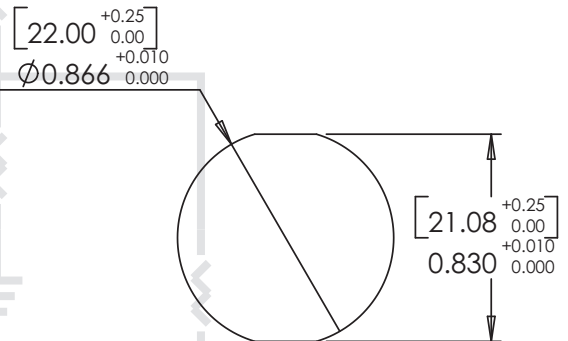

800.544.3354

www.itwactivetouch.com

U.S. Patents: 6933932, 7026943, 7053529, 7106310.
U.S. Patents Pending: 03797865.7, 04776790.0, 04776791.8, 02761841.2, 02763786.7, 04754763.4

5 VDC Input / Digital Output

BEYOND DURABLE.™

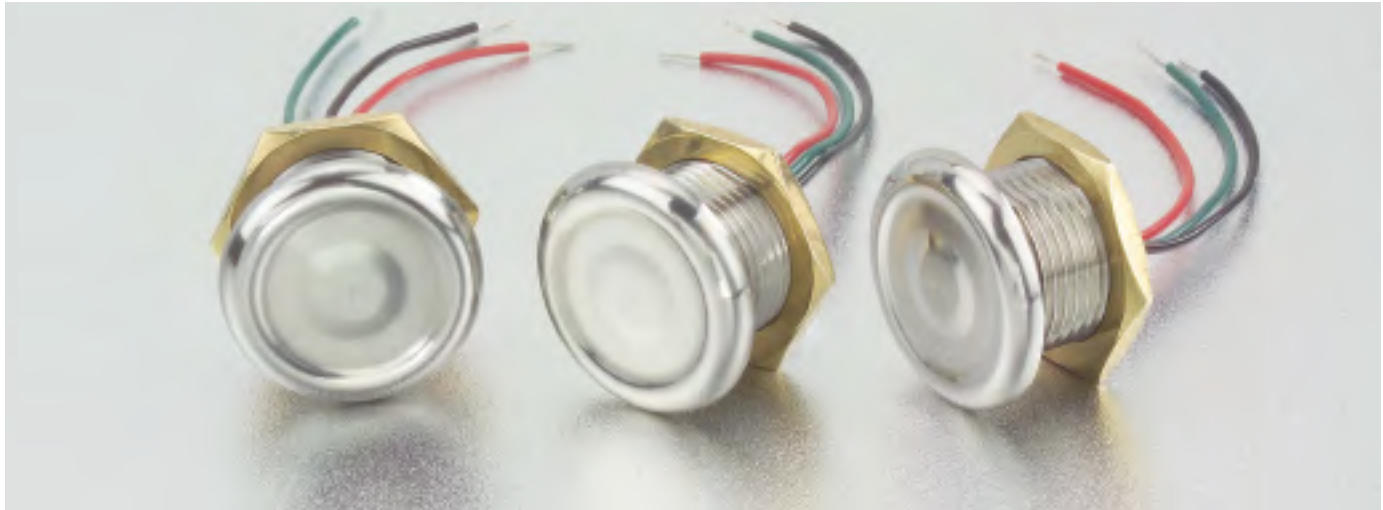

5 VDC Input / Digital Output:

22mm Stainless Steel (316) switch with 5 VDC input and digital output. Either momentary or alternate action programmed to level 2 sensitivity. Each switch has 24 AWG, 12" long, insulated wire leads.

Part Number	Normally Open	Normally Closed	Normally High, 5V	Normally Low, 0V	Momentary Action	Alternate Action	Sensitivity Level	Color
T01-012201-001-NH-M-2		✓		✓		2	ST	
T01-012201-001-NH-A-2		✓			✓	2	ST	
T01-012201-001-NL-M-2			✓	✓		2	ST	
T01-012201-001-NL-A-2			✓		✓	2	ST	

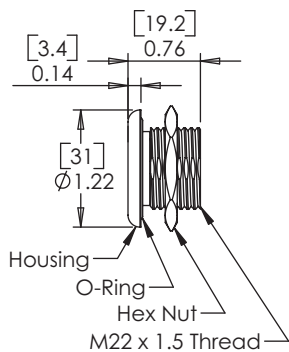

Detailed technical information on **Input /Output** types, **Switch Status**, **Switch Action**, **Sensitivity Levels**, and **Mounting Information** can be found in the **Appendix starting on page 37**.

800.544.3354

Contact an Authorized Distributor or Factory for Pricing

www.itwactivetouch.com

ActiveMetal™

BEYOND DURABLE.™

5 VDC or 10 – 24 VDC Input / Open Collector Output

5 VDC Input / Open Collector Output:

22mm Stainless Steel (316) switch with 5 VDC input and open collector output. Either momentary or alternate action programmed to level 2 sensitivity. Each switch has 24 AWG, 12" long, insulated wire leads.

Part Number	Normally Open	Normally Closed	Normally High, 5V	Normally Low, 0V	Momentary Action	Alternate Action	Sensitivity Level	Color
T01-012202-001-NO-M-2	✓			✓		2	ST	
T01-012202-001-NO-A-2	✓				✓	2	ST	
T01-012202-001-NC-M-2		✓		✓		2	ST	
T01-012202-001-NC-A-2		✓			✓	2	ST	

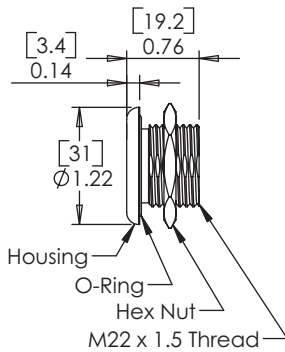

Detailed technical information on [Input /Output](#) types, [Switch Status](#), [Switch Action](#), [Sensitivity Levels](#), and [Mounting Information](#) can be found in the [Appendix starting on page 37](#).

10 – 24 VDC Input / Open Collector Output:

22mm Stainless Steel (316) switch with 10–24 VDC input and open collector output. Either momentary or alternate action programmed to level 2 sensitivity. Each switch has 24 AWG, 12" long, insulated wire leads.

Part Number	Normally Open	Normally Closed	Normally High, 5V	Normally Low, 0V	Momentary Action	Alternate Action	Sensitivity Level	Color
T01-012203-001-NO-M-2	✓			✓		2	ST	
T01-012203-001-NO-A-2	✓				✓	2	ST	
T01-012203-001-NC-M-2		✓		✓		2	ST	
T01-012203-001-NC-A-2		✓			✓	2	ST	

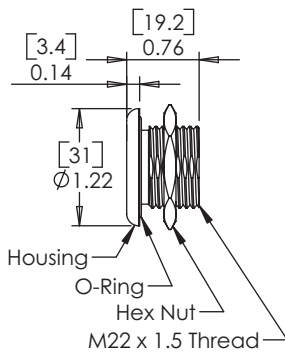

Detailed technical information on [Input /Output](#) types, [Switch Status](#), [Switch Action](#), [Sensitivity Levels](#), and [Mounting Information](#) can be found in the [Appendix starting on page 37](#).

800.544.3354

www.itwactivetouch.com

Contact an Authorized Distributor or Factory for Pricing

5 VDC Input / Digital Output

BEYOND DURABLE.™



5 VDC Input / Digital Output:

22mm Aluminum Alloy (6061) switch, with Type II anodization and 5 VDC input and digital output. Either momentary or alternate action programmed to level 2 sensitivity. Each switch has 24 AWG, 12" long, insulated wire leads.

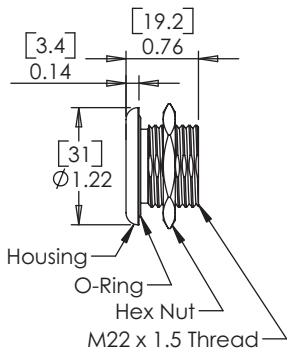

Part Number	Normally Open	Normally Closed	Normally High, 5V	Normally Low, 0V	Momentary Action	Alternate Action	Sensitivity Level	Color
T01-022201-001-NH-M-2		✓		✓		2	2	CLR
T01-022201-001-NH-A-2		✓			✓	2	2	CLR
T01-022201-001-NL-M-2			✓	✓		2	2	CLR
T01-022201-001-NL-A-2			✓		✓	2	2	CLR
T01-022201-002-NH-M-2		✓		✓		2	2	BLK
T01-022201-002-NH-A-2		✓			✓	2	2	BLK
T01-022201-002-NL-M-2			✓	✓		2	2	BLK
T01-022201-002-NL-A-2			✓		✓	2	2	BLK
T01-022201-003-NH-M-2		✓		✓		2	2	RED
T01-022201-003-NH-A-2		✓			✓	2	2	RED
T01-022201-003-NL-M-2			✓	✓		2	2	RED
T01-022201-003-NL-A-2			✓		✓	2	2	RED
T01-022201-004-NH-M-2		✓		✓		2	2	GRN
T01-022201-004-NH-A-2		✓			✓	2	2	GRN
T01-022201-004-NL-M-2			✓	✓		2	2	GRN
T01-022201-004-NL-A-2			✓		✓	2	2	GRN

Detailed technical information on [Input /Output types](#), [Switch Status](#), [Switch Action](#), [Sensitivity Levels](#), and [Mounting Information](#) can be found in the [Appendix starting on page 37](#).

800.544.3354

Contact an Authorized Distributor or Factory for Pricing

www.itwactivetouch.com

ActiveMetal™

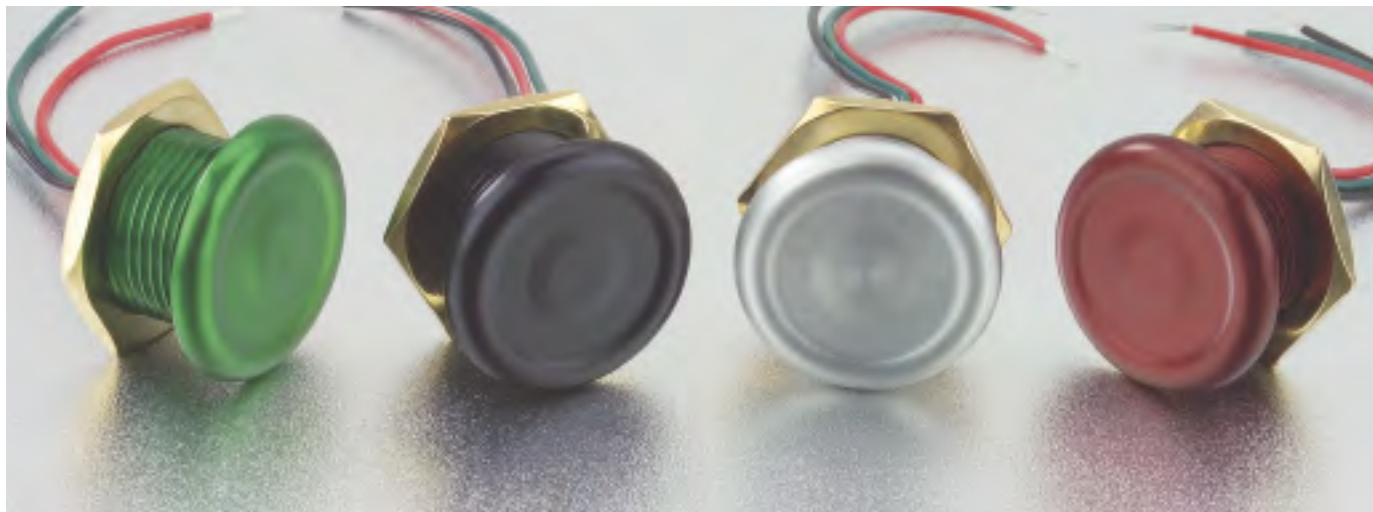

**5 VDC Input /
Open Collector Output:**

22mm Aluminum Alloy (6061) switch, with Type II anodization and 5 VDC input and open collector output. Either momentary or alternate action programmed to level 2 sensitivity. Each switch has 24 AWG, 12" long, insulated wire leads.

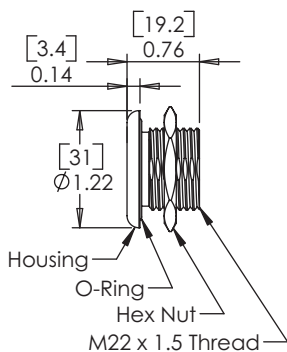

Part Number	Normally Open	Normally Closed	Normally High, 5V	Normally Low, 0V	Momentary Action	Alternate Action	Sensitivity Level	Color
T01-022202-001-NO-M-2	✓			✓		2	CLR	
T01-022202-001-NO-A-2	✓			✓	✓	2	CLR	
T01-022202-001-NC-M-2		✓		✓		2	CLR	
T01-022202-001-NC-A-2		✓		✓	✓	2	CLR	
T01-022202-002-NO-M-2	✓			✓		2	BLK	
T01-022202-002-NO-A-2	✓			✓	✓	2	BLK	
T01-022202-002-NC-M-2		✓		✓		2	BLK	
T01-022202-002-NC-A-2		✓		✓	✓	2	BLK	
T01-022202-003-NO-M-2	✓			✓		2	RED	
T01-022202-003-NO-A-2	✓			✓	✓	2	RED	
T01-022202-003-NC-M-2		✓		✓		2	RED	
T01-022202-003-NC-A-2		✓		✓	✓	2	RED	
T01-022202-004-NO-M-2	✓			✓		2	GRN	
T01-022202-004-NO-A-2	✓			✓	✓	2	GRN	
T01-022202-004-NC-M-2		✓		✓		2	GRN	
T01-022202-004-NC-A-2		✓		✓	✓	2	GRN	

Detailed technical information on [Input /Output](#) types, [Switch Status](#), [Switch Action](#), [Sensitivity Levels](#), and [Mounting Information](#) can be found in the [Appendix starting on page 37](#).

800.544.3354

www.itwactivetouch.com

Contact an Authorized Distributor or Factory for Pricing

10 – 24 VDC Input / Open Collector Output

BEYOND DURABLE.™



10 – 24 VDC Input / Open Collector Output:

22mm Aluminum Alloy (6061) switch, with Type II anodization and 10–24 VDC input and open collector output. Either momentary or alternate action programmed to level 2 sensitivity. Each switch has 24 AWG, 12" long, insulated wire leads.

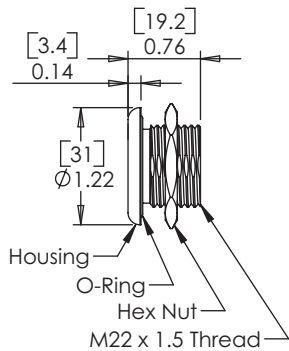

Part Number	Normally Open	Normally Closed	Normally High, 5V	Normally Low, 0V	Momentary Action	Alternate Action	Sensitivity Level	Color
T01-022203-001-NO-M-2	✓			✓		2	CLR	
T01-022203-001-NO-A-2	✓				✓	2	CLR	
T01-022203-001-NC-M-2		✓		✓		2	CLR	
T01-022203-001-NC-A-2		✓			✓	2	CLR	
T01-022203-002-NO-M-2	✓			✓		2	BLK	
T01-022203-002-NO-A-2	✓				✓	2	BLK	
T01-022203-002-NC-M-2		✓		✓		2	BLK	
T01-022203-002-NC-A-2		✓			✓	2	BLK	
T01-022203-003-NO-M-2	✓			✓		2	RED	
T01-022203-003-NO-A-2	✓				✓	2	RED	
T01-022203-003-NC-M-2		✓		✓		2	RED	
T01-022203-003-NC-A-2		✓			✓	2	RED	
T01-022203-004-NO-M-2	✓			✓		2	GRN	
T01-022203-004-NO-A-2	✓				✓	2	GRN	
T01-022203-004-NC-M-2		✓		✓		2	GRN	
T01-022203-004-NC-A-2		✓			✓	2	GRN	

Detailed technical information on [Input /Output](#) types, [Switch Status](#), [Switch Action](#), [Sensitivity Levels](#), and [Mounting Information](#) can be found in the [Appendix starting on page 37](#).

800.544.3354

Contact an Authorized Distributor or Factory for Pricing

www.itwactivetouch.com

ActiveMetal™

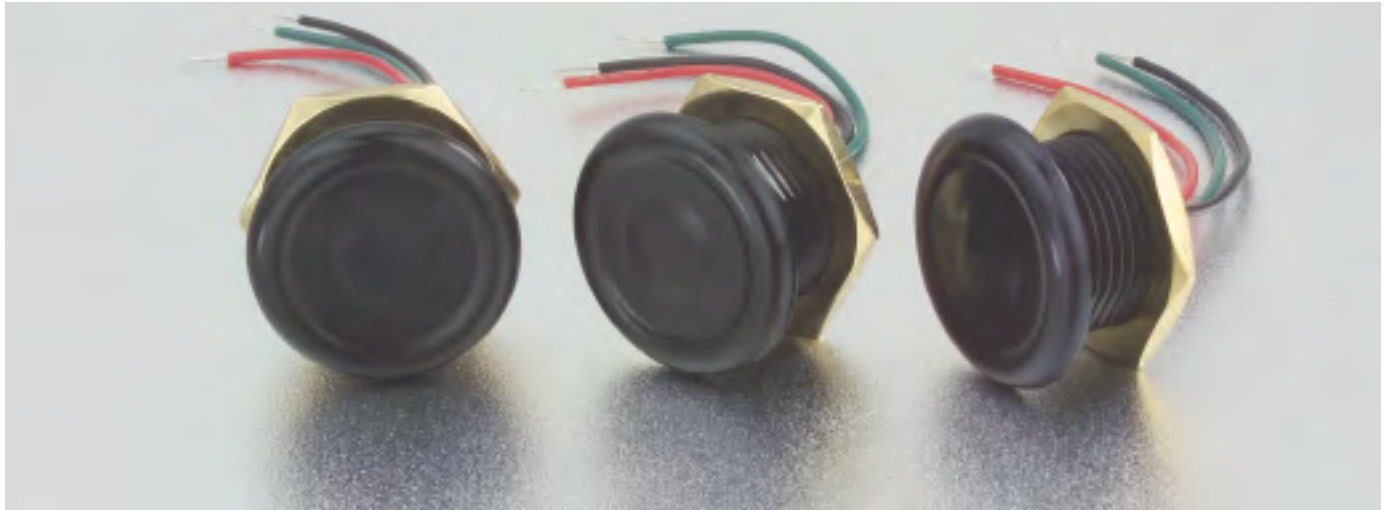

5 VDC Input / Digital Output:

22mm Plastic (PPS) switch, with 5 VDC input and digital output. Either momentary or alternate action programmed to level 2 sensitivity. Each switch has 24 AWG, 12" long, insulated wire leads.

Part Number	Normally Open	Normally Closed	Normally High, 5V	Normally Low, 0V	Momentary Action	Alternate Action	Sensitivity Level	Color
T01-032201-001-NH-M-2		✓		✓		2	BLK	
T01-032201-001-NH-A-2		✓			✓	2	BLK	
T01-032201-001-NL-M-2			✓	✓		2	BLK	
T01-032201-001-NL-A-2			✓		✓	2	BLK	

Products on this page are not available until Fall 2007.

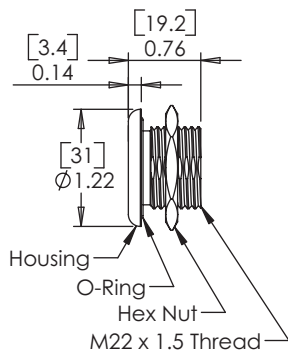

Detailed technical information on **Input /Output** types, **Switch Status**, **Switch Action**, **Sensitivity Levels**, and **Mounting Information** can be found in the **Appendix starting on page 37**.

800.544.3354

www.itwactivetouch.com

Contact an Authorized Distributor or Factory for Pricing

5 VDC or 10 – 24 VDC Input / Open Collector Output

BEYOND DURABLE.™

5 VDC Input / Open Collector Output:

22mm Plastic (PPS) switch, with 5 VDC input and open collector output. Either momentary or alternate action programmed to level 2 sensitivity. Each switch has 24 AWG, 12" long, insulated wire leads.

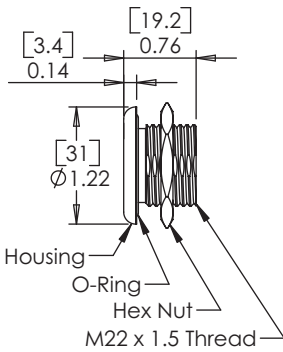

Part Number	Normally Open	Normally Closed	Normally High, 5V	Normally Low, 0V	Momentary Action	Alternate Action	Sensitivity Level	Color
T01-032202-001-NO-M-2	✓			✓		2	BLK	
T01-032202-001-NO-A-2	✓				✓	2	BLK	
T01-032202-001-NC-M-2		✓		✓		2	BLK	
T01-032202-001-NC-A-2		✓			✓	2	BLK	

Products on this page are not available until Fall 2007.

Detailed technical information on [Input /Output](#) types, [Switch Status](#), [Switch Action](#), [Sensitivity Levels](#), and [Mounting Information](#) can be found in the [Appendix starting on page 37](#).

10 – 24 VDC Input / Open Collector Output:

22mm Plastic (PPS) switch, with 10–24 VDC input and open collector output. Either momentary or alternate action programmed to level 2 sensitivity. Each switch has 24 AWG, 12" long, insulated wire leads.

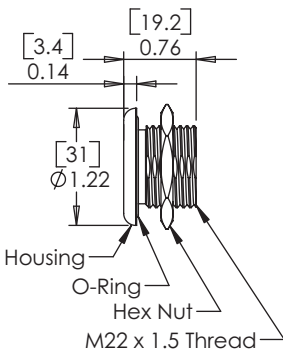

Part Number	Normally Open	Normally Closed	Normally High, 5V	Normally Low, 0V	Momentary Action	Alternate Action	Sensitivity Level	Color
T01-032203-001-NO-M-2	✓			✓		2	BLK	
T01-032203-001-NO-A-2	✓				✓	2	BLK	
T01-032203-001-NC-M-2		✓		✓		2	BLK	
T01-032203-001-NC-A-2		✓			✓	2	BLK	

Products on this page are not available until Fall 2007.

Detailed technical information on [Input /Output](#) types, [Switch Status](#), [Switch Action](#), [Sensitivity Levels](#), and [Mounting Information](#) can be found in the [Appendix starting on page 37](#).

800.544.3354

Contact an Authorized Distributor or Factory for Pricing

www.itwactivetouch.com

ActiveMetal™



30mm SWITCHES

BEYOND DURABLE.™

||TW ActiveTouch™
SENSORS, SWITCHES, ELECTRONIC CONTROLS

BEYOND DURABLE™

MECHANICAL SPECIFICATIONS

- Maximum Actuation Force:
Level 2 Sensitivity: < 5 lbs. (22.2 N)
ADA Compliant
- Materials: Stainless Steel (316),
Aluminum (6061) with Type II Anodization
- Mechanism: 100% Solid-state, No Moving Parts
- Operational Life: Tested +20MM cycles, -60°C to 85°C (Typical)
- Mounting Panel Thickness: 0.0312" (0.97mm) to
0.469" (11.9mm)
- Mounting Panel Thickness with oriented
Double "D" Flats: 0.090" (2.3mm) to
0.469" (11.9mm)
- Mounting: Brass Nut (15 Inch Pounds — Max),
AS568A-026 Butyl Rubber O-ring

ENVIRONMENTAL SPECIFICATIONS

- Operating Temperature Range: -40° C to +85° C (Typical)
- Storage Temperature Range: -60° C to +165° C (Typical)
- Relative Humidity: No Effect
- Ingress Protection: IP68 (submerged in 3 feet without a panel for 96 hours)
- Shock: Tested to 30g in each Axis
(drop test from 20 ft to concrete)
- Vibration: Tested at 4 hours each Axis
(actuated during vibration)
- Impact: 1kg Shock Test

ELECTRICAL SPECIFICATIONS

- Voltage: +5 VDC ± 5%, or
+10–24 VDC
- Current: 100mA
- Contact Resistance: None
- Contact Bounce: None
- EMI/RFI: No Effect
- ESD: 25kv in each method
- Wire Leads: 24 AWG,
12" long,
105C Insulation

FUNCTIONAL OPERATION SPECIFICATIONS

- Momentary / Alternate
- Normally Open / Normally Closed
(Open Collector Output)
- Normally High, 5V / Normally Low, 0V
(Digital Output)
- Make / Break via Transistor

PANEL CUTOUTS:

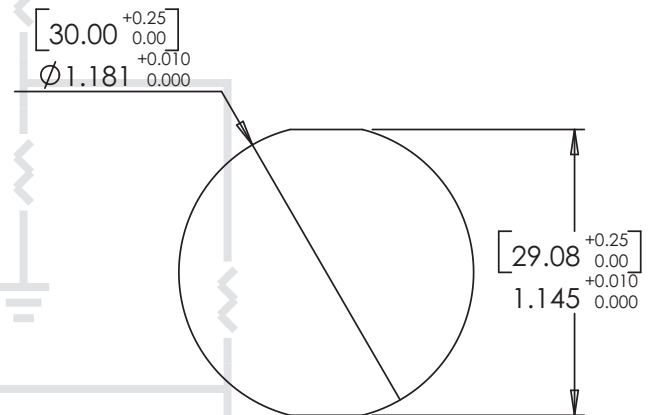

800.544.3354

www.itwactivetouch.com

U.S. Patents: 6933932, 7026943, 7053529, 7106310.
U.S. Patents Pending: 03797865.7, 04776790.0, 04776791.8, 02761841.2, 02763786.7, 04754763.4

5 VDC Input / Digital Output

BEYOND DURABLE.™

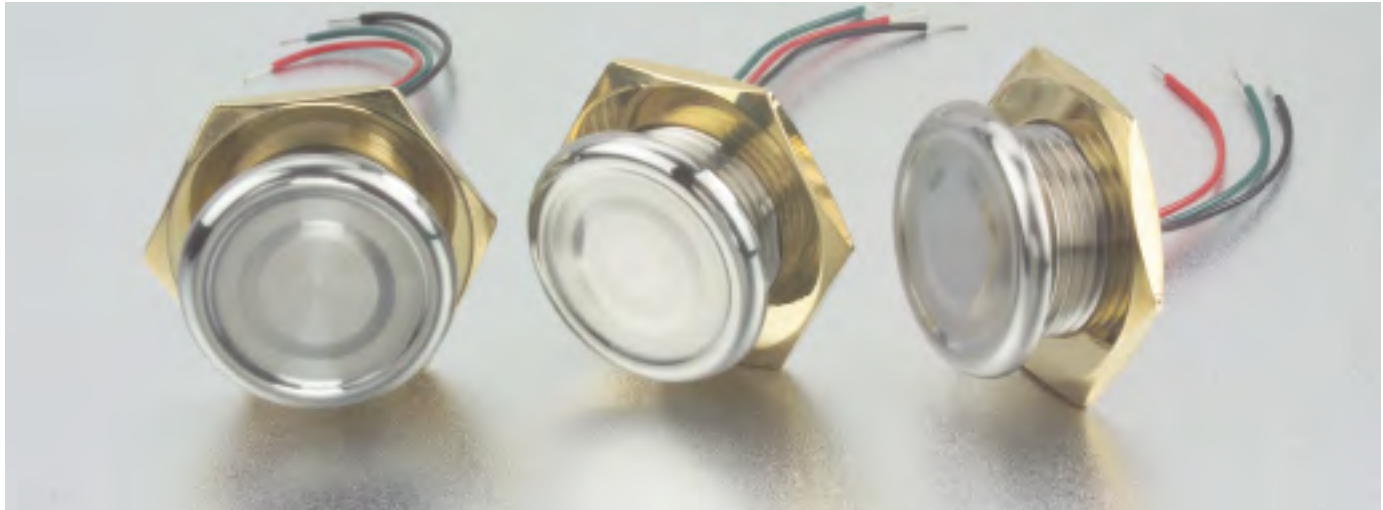

5 VDC Input / Digital Output:

30mm Stainless Steel (316) switch with 5 VDC input and digital output. Either momentary or alternate action programmed to level 2 sensitivity. Each switch has 24 AWG, 12" long, insulated wire leads.

Part Number	Normally Open	Normally Closed	Normally High, 5V	Normally Low, 0V	Momentary Action	Alternate Action	Sensitivity Level	Color
T01-013001-001-NH-M-2		✓		✓		2	ST	
T01-013001-001-NH-A-2		✓			✓	2	ST	
T01-013001-001-NL-M-2			✓	✓		2	ST	
T01-013001-001-NL-A-2			✓		✓	2	ST	

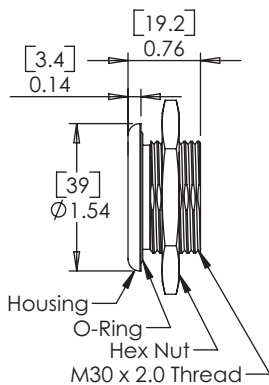

Detailed technical information on **Input /Output** types, **Switch Status**, **Switch Action**, **Sensitivity Levels**, and **Mounting Information** can be found in the **Appendix starting on page 37**.

800.544.3354

Contact an Authorized Distributor or Factory for Pricing

www.itwactivetouch.com

ActiveMetal™

BEYOND DURABLE.™

5 VDC or 10 – 24 VDC Input / Open Collector Output

**5 VDC Input /
Open Collector Output:**

30mm Stainless Steel (316) switch with 5 VDC input and open collector output. Either momentary or alternate action programmed to level 2 sensitivity. Each switch has 24 AWG, 12" long, insulated wire leads.

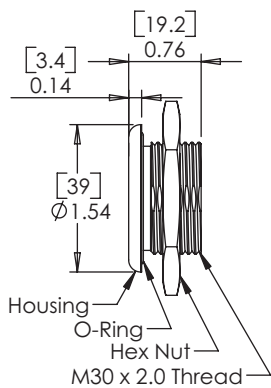

Part Number	Normally Open	Normally Closed	Normally High, 5V	Normally Low, 0V	Momentary Action	Alternate Action	Sensitivity Level	Color
T01-013002-001-NO-M-2	✓			✓		2	ST	
T01-013002-001-NO-A-2	✓				✓	2	ST	
T01-013002-001-NC-M-2		✓		✓		2	ST	
T01-013002-001-NC-A-2		✓			✓	2	ST	

Detailed technical information on [Input /Output](#) types, [Switch Status](#), [Switch Action](#), [Sensitivity Levels](#), and [Mounting Information](#) can be found in the [Appendix starting on page 37](#).

**10 – 24 VDC Input /
Open Collector Output:**

30mm Stainless Steel (316) switch with 10–24 VDC input and open collector output. Either momentary or alternate action programmed to level 2 sensitivity. Each switch has 24 AWG, 12" long, insulated wire leads.

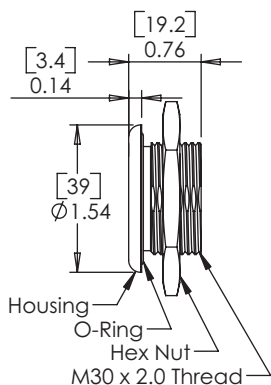

Part Number	Normally Open	Normally Closed	Normally High, 5V	Normally Low, 0V	Momentary Action	Alternate Action	Sensitivity Level	Color
T01-013003-001-NO-M-2	✓			✓		2	ST	
T01-013003-001-NO-A-2	✓				✓	2	ST	
T01-013003-001-NC-M-2		✓		✓		2	ST	
T01-013003-001-NC-A-2		✓			✓	2	ST	

Detailed technical information on [Input /Output](#) types, [Switch Status](#), [Switch Action](#), [Sensitivity Levels](#), and [Mounting Information](#) can be found in the [Appendix starting on page 37](#).

800.544.3354

www.itwactivetouch.com

Contact an Authorized Distributor or Factory for Pricing

5 VDC Input / Digital Output

BEYOND DURABLE.™



5 VDC Input / Digital Output:

30mm Aluminum Alloy (6061) switch, with Type II anodization and 5 VDC input and digital output. Either momentary or alternate action programmed to level 2 sensitivity. Each switch has 24 AWG, 12" long, insulated wire leads.

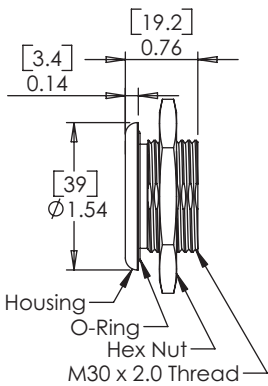

Part Number	Normally Open	Normally Closed	Normally High, 5V	Normally Low, 0V	Momentary Action	Alternate Action	Sensitivity Level	Color
T01-023001-001-NH-M-2		✓		✓		2	2	CLR
T01-023001-001-NH-A-2		✓			✓	2	2	CLR
T01-023001-001-NL-M-2			✓	✓		2	2	CLR
T01-023001-001-NL-A-2			✓		✓	2	2	CLR
T01-023001-002-NH-M-2		✓		✓		2	2	BLK
T01-023001-002-NH-A-2		✓			✓	2	2	BLK
T01-023001-002-NL-M-2			✓	✓		2	2	BLK
T01-023001-002-NL-A-2			✓		✓	2	2	BLK
T01-023001-003-NH-M-2		✓		✓		2	2	RED
T01-023001-003-NH-A-2		✓			✓	2	2	RED
T01-023001-003-NL-M-2			✓	✓		2	2	RED
T01-023001-003-NL-A-2			✓		✓	2	2	RED
T01-023001-004-NH-M-2		✓		✓		2	2	GRN
T01-023001-004-NH-A-2		✓			✓	2	2	GRN
T01-023001-004-NL-M-2			✓	✓		2	2	GRN
T01-023001-004-NL-A-2			✓		✓	2	2	GRN

Detailed technical information on [Input /Output types](#), [Switch Status](#), [Switch Action](#), [Sensitivity Levels](#), and [Mounting Information](#) can be found in the [Appendix starting on page 37](#).

800.544.3354

Contact an Authorized Distributor or Factory for Pricing

www.itwactivetouch.com

ActiveMetal™

BEYOND DURABLE™

5 VDC Input / Open Collector Output



**5 VDC Input /
Open Collector Output:**

30mm Aluminum Alloy (6061) switch, with Type II anodization and 5 VDC input and open collector output. Either momentary or alternate action programmed to level 2 sensitivity. Each switch has 24 AWG, 12" long, insulated wire leads.

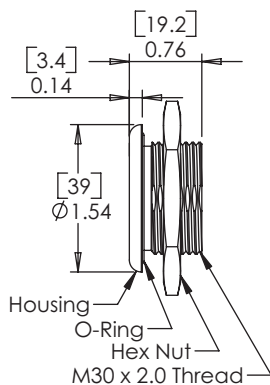

Part Number	Normally Open	Normally Closed	Normally High, 5V	Normally Low, 0V	Momentary Action	Alternate Action	Sensitivity Level	Color
T01-023002-001-NO-M-2	✓			✓		2	2	CLR
T01-023002-001-NO-A-2	✓				✓	2	2	CLR
T01-023002-001-NC-M-2		✓		✓		2	2	CLR
T01-023002-001-NC-A-2		✓			✓	2	2	CLR
T01-023002-002-NO-M-2	✓			✓		2	2	BLK
T01-023002-002-NO-A-2	✓				✓	2	2	BLK
T01-023002-002-NC-M-2		✓		✓		2	2	BLK
T01-023002-002-NC-A-2		✓			✓	2	2	BLK
T01-023002-003-NO-M-2	✓			✓		2	2	RED
T01-023002-003-NO-A-2	✓				✓	2	2	RED
T01-023002-003-NC-M-2		✓		✓		2	2	RED
T01-023002-003-NC-A-2		✓			✓	2	2	RED
T01-023002-004-NO-M-2	✓			✓		2	2	GRN
T01-023002-004-NO-A-2	✓				✓	2	2	GRN
T01-023002-004-NC-M-2		✓		✓		2	2	GRN
T01-023002-004-NC-A-2		✓			✓	2	2	GRN

Detailed technical information on [Input /Output](#) types, [Switch Status](#), [Switch Action](#), [Sensitivity Levels](#), and [Mounting Information](#) can be found in the [Appendix starting on page 37](#).

800.544.3354

www.itwactivetouch.com

Contact an Authorized Distributor or Factory for Pricing

10 – 24 VDC Input / Open Collector Output

BEYOND DURABLE.™



10 – 24 VDC Input / Open Collector Output:

30mm Aluminum Alloy (6061) switch, with Type II anodization and 10–24 VDC input and open collector output. Either momentary or alternate action programmed to level 2 sensitivity. Each switch has 24 AWG, 12" long, insulated wire leads.

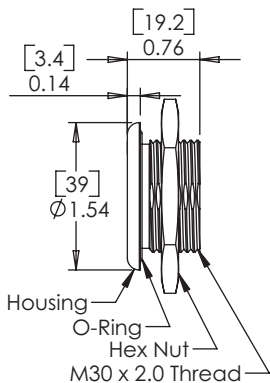

Part Number	Normally Open	Normally Closed	Normally High, 5V	Normally Low, 0V	Momentary Action	Alternate Action	Sensitivity Level	Color
T01-023003-001-NO-M-2	✓			✓		2	CLR	
T01-023003-001-NO-A-2	✓				✓	2	CLR	
T01-023003-001-NC-M-2		✓		✓		2	CLR	
T01-023003-001-NC-A-2		✓			✓	2	CLR	
T01-023003-002-NO-M-2	✓			✓		2	BLK	
T01-023003-002-NO-A-2	✓				✓	2	BLK	
T01-023003-002-NC-M-2		✓		✓		2	BLK	
T01-023003-002-NC-A-2		✓			✓	2	BLK	
T01-023003-003-NO-M-2	✓			✓		2	RED	
T01-023003-003-NO-A-2	✓				✓	2	RED	
T01-023003-003-NC-M-2		✓		✓		2	RED	
T01-023003-003-NC-A-2		✓			✓	2	RED	
T01-023003-004-NO-M-2	✓			✓		2	GRN	
T01-023003-004-NO-A-2	✓				✓	2	GRN	
T01-023003-004-NC-M-2		✓		✓		2	GRN	
T01-023003-004-NC-A-2		✓			✓	2	GRN	

Detailed technical information on [Input /Output](#) types, [Switch Status](#), [Switch Action](#), [Sensitivity Levels](#), and [Mounting Information](#) can be found in the [Appendix starting on page 37](#).

800.544.3354

Contact an Authorized Distributor or Factory for Pricing

www.itwactivetouch.com

ActiveMetal™



38mm SWITCHES

BEYOND DURABLE.™

||TW ActiveTouch™
SENSORS, SWITCHES, ELECTRONIC CONTROLS

BEYOND DURABLE™

MECHANICAL SPECIFICATIONS

- Maximum Actuation Force:
Level 2 Sensitivity: < 5 lbs. (22.2 N)
ADA Compliant
- Materials: Stainless Steel (316)
- Mechanism: 100% Solid-state, No Moving Parts
- Operational Life: Tested +20MM cycles, -60°C to 85°C (Typical)
- Mounting Panel Thickness: 2mm (0.079")
- Mounting: 1.5" (38.1mm) External / Spiral Retaining Ring with an AS568A-030 Buna-N O-ring

ENVIRONMENTAL SPECIFICATIONS

- Operating Temperature Range: -40° C to +85° C (Typical)
- Storage Temperature Range: -60° C to +165° C (Typical)
- Relative Humidity: No Effect
- Ingress Protection: IP68 (submerged in 3 feet without a panel for 96 hours)
- Shock: Tested to 30g in each Axis (drop test from 20 ft to concrete)
- Vibration: Tested at 4 hours each Axis (actuated during vibration)
- Impact: 1kg Shock Test

ELECTRICAL SPECIFICATIONS

- Voltage: +5 VDC ± 5%
- Contact Resistance: None
- Contact Bounce: None
- EMI/RFI: No Effect
- ESD: 25kv in each method
- Termination: Molex 3-position (female) connector, 22 AWG, 2.77" long, 105C Insulated wire leads

FUNCTIONAL OPERATION SPECIFICATIONS

- Momentary / Alternate
- Normally Open / Normally Closed (Open Collector Output)
- Normally High, 5V / Normally Low, 0V (Digital Output)
- Make / Break via Transistor

PANEL CUTOUTS:

[38.48 ±0.13]
Ø1.515 ±0.005

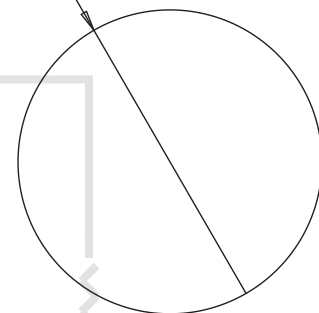

800.544.3354

www.itwactivetouch.com

U.S. Patents: 6933932, 7026943, 7053529, 7106310.
U.S. Patents Pending: 03797865.7, 04776790.0, 04776791.8, 02761841.2, 02763786.7, 04754763.4

5 VDC Input / Digital Output

BEYOND DURABLE.™



5 VDC Input / Digital Output:

38mm Stainless Steel (316) switch with 5 VDC input and digital output. Either momentary or alternate action programmed to level 2 sensitivity. Each switch is terminated with a Molex 3-position (female) connector and has 22 AWG, 2.77" long, insulated wires.

Part Number	Normally Open	Normally Closed	Normally High, 5V	Normally Low, 0V	Momentary Action	Alternate Action	Sensitivity Level	Color
T01-013801-001-NH-M-2		✓		✓		2	ST	
T01-013801-001-NH-A-2		✓			✓	2	ST	
T01-013801-001-NL-M-2			✓	✓		2	ST	
T01-013801-001-NL-A-2			✓		✓	2	ST	

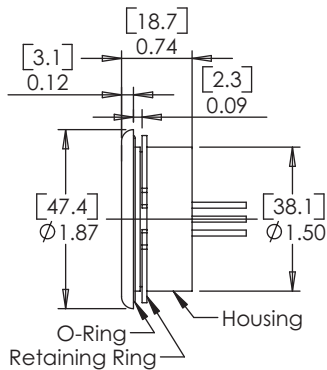

Detailed technical information on [Input /Output](#) types, [Switch Status](#), [Switch Action](#), [Sensitivity Levels](#), and [Mounting Information](#) can be found in the [Appendix starting on page 37](#).

800.544.3354

Contact an Authorized Distributor or Factory for Pricing

www.itwactivetouch.com

ActiveMetal™

APPENDIX

BEYOND DURABLE.™

***TW* ActiveTouch™**
SENSORS, SWITCHES, ELECTRONIC CONTROLS

BEYOND DURABLE.™

INPUT / OUTPUT:

- **5VDC Input / Digital Output** — 5VDC Input (red wire) and Digital Output (green wire) is output either at 5V or 0V level relative to input voltage supply's ground (black wire).
- **5VDC Input / Open Collector Output** — 5VDC Input (red wire) and Open Collector Output (green wire) is output that is open or closed relative to input voltage supply's ground (black wire).
- **10 – 24VDC Input / Open Collector Output** — Will work with any input operating voltage between 10 – 24VDC (red wire) and Open Collector Output (green wire) is output that is open or closed relative to input voltage supply's ground (black wire).

SWITCH STATUS:

- **Normally Open** — An unactivated condition, output is open relative to input voltage supply's ground (sinking output).
- **Normally Closed** — An unactivated condition, output is closed relative to input voltage supply's ground (sinking output).
- **Normally High, 5V** — An unactivated condition, output at 5V level relative to input voltage supply's ground.
- **Normally Low, 0V** — An unactivated condition, output at 0V level relative to input voltage supply's ground.

SWITCH ACTION:

- **Momentary Action** — Output reverts to its previous status as the switch goes into the unactivated condition.
- **Alternate Action** — Output changes to its opposite status and latches as a result of the switch activation.

SWITCH SENSITIVITY LEVELS:

- **Level 1** — Designed for indoor use with or without a gloved hand (0g force); may be susceptible to false activations caused by water or an accidental touch.
- **Level 2** — Designed for indoor / outdoor use with or without a gloved hand; impervious to false activations caused by water.
- **Level 3** — Designed for indoor / outdoor use without a gloved hand (heavy force required); impervious to false activations.

MOUNTING:

All of the ActiveMetal products featured in this catalog are designed to be panel mounted. The 19mm, 22mm and 30mm are threaded and have two D-flats to prevent rotation, each is supplied with an O-ring and mounting nut for installation. The 38mm is non-threaded and is supplied with an O-ring and retaining ring for installation. Each switch's specifications, recommended panel thickness and panel cutout drawing can be found on the Switches' Characteristics page:

- **19mm** — See page 7.
- **22mm** — See page 15.
- **30mm** — See page 25.
- **38mm** — See page 33.

800.544.3354

www.itwactivetouch.com

Purchaser is solely responsible for determining whether any Product is fit for a particular purpose and suitable for Purchaser's method of application. Accordingly, and due to the nature and manner of use of Seller's Products, Seller is not responsible for the results or consequences of use, misuse or application of its Products by anyone.



**2550 Millbrook Drive
Buffalo Grove, IL 60089**

800.544.3354

847.876.9400

847.876.9440 (Fax)

www.itwactivetouch.com

Distributed Via:

ITW Switches

Authorized Distributors

800.544.3354

www.itwswitches.com

ITW ACTIVETOUCH OFFICE LOCATIONS

Buffalo Grove, Illinois — Worldwide Headquarters

Round Rock, Texas — R&D

Des Plaines, Illinois — Appliance

Glenview, Illinois — R&D and Automotive

Milan, Italy — Appliance

Kaohsiung, Taiwan — Sales

Portsmouth, England — Sales